

Stereo Vision IP Core

Data Sheet

(v1.7) February 23, 2017



Nerian Vision Technologies
Dr. Konstantin Schauwecker
Gotenstr. 9
70771 Leinfelden-Echterdingen
Germany

Email: service@nerian.com
<http://nerian.com>

Contents

| | | |
|-----------|---|-----------|
| 1 | Introduction | 3 |
| 2 | Features | 3 |
| 3 | Background | 4 |
| 3.1 | Camera Alignment | 4 |
| 3.2 | Image Rectification | 4 |
| 3.3 | Camera Calibration | 5 |
| 3.4 | Disparity Maps | 5 |
| 4 | Stereo Vision Core Functionality | 6 |
| 4.1 | Rectification | 8 |
| 4.2 | Image Pre-Processing | 8 |
| 4.3 | Stereo Matching | 8 |
| 4.4 | Cost Volume Post-Processing | 9 |
| 4.4.1 | Subpixel Optimization | 9 |
| 4.4.2 | Uniqueness Check | 10 |
| 4.4.3 | Consistency Check | 10 |
| 4.5 | Disparity Map Post-Processing | 10 |
| 4.5.1 | Texture Filtering | 10 |
| 4.5.2 | Speckle Filtering | 10 |
| 4.5.3 | Gap Interpolation | 11 |
| 4.5.4 | Noise Reduction | 11 |
| 5 | DMA Core Functionality | 11 |
| 5.1 | Ports Connected to SVC | 11 |
| 5.2 | Interface Ports | 12 |
| 5.3 | Output Conversion | 13 |
| 5.3.1 | Split Disparity Map | 13 |
| 5.3.2 | Extended Disparities | 13 |
| 6 | Parameterization | 14 |
| 6.1 | SVC Parameters | 14 |
| 6.2 | DMA Core Parameters | 16 |
| 7 | Supported Devices | 16 |
| 8 | Timing | 17 |
| 9 | Resource Usage | 17 |
| 10 | IO Signals | 17 |
| 11 | Registers | 22 |
| 11.1 | DMA Core Registers | 22 |
| 11.1.1 | 0x00: Control | 22 |
| 11.1.2 | 0x04: Status | 22 |

| | | |
|-----------|---|-----------|
| 11.1.3 | 0x08: Image Size | 24 |
| 11.1.4 | 0x0C: Output Address | 24 |
| 11.1.5 | 0x10: Output Bytes Available | 24 |
| 11.1.6 | 0x14: Output FIFO Info | 24 |
| 11.1.7 | 0x18: Left Input Address | 24 |
| 11.1.8 | 0x1C: Left Input Bytes Available | 25 |
| 11.1.9 | 0x20: Right Input Address | 25 |
| 11.1.10 | 0x24: Right Input Bytes Available | 25 |
| 11.1.11 | 0x28: Input FIFO Info | 25 |
| 11.1.12 | 0x2C: Rectification Map Address | 25 |
| 11.1.13 | 0x30: Rectification Map FIFO Info | 25 |
| 11.1.14 | 0x34: Buffer Address | 26 |
| 11.1.15 | 0x38: Buffer FIFO Info | 26 |
| 11.2 | SVC Registers | 26 |
| 11.2.1 | 0x00: Control | 26 |
| 11.2.2 | 0x04: Image Size | 26 |
| 11.2.3 | 0x08: Algorithm Parameters 1 | 27 |
| 11.2.4 | 0x0C: Algorithm Parameters 2 | 27 |
| 11.2.5 | 0x10: License Key Higher 32 Bits | 27 |
| 11.2.6 | 0x14: License Key Lower 32 Bits | 28 |
| 11.2.7 | 0x18: Device DNA Higher 25 Bits | 28 |
| 11.2.8 | 0x1C: Device DNA Lower 32 Bits | 28 |
| 12 | Reference Design | 28 |
| 13 | Control Flow | 28 |
| 13.1 | One-Time Initializations | 30 |
| 13.2 | Per-Frame Control Flow | 30 |
| 13.3 | Result Retrieval | 31 |

1 Introduction

The Stereo Vision Core (SVC) performs stereo matching on two grayscale input images. The images are first rectified to compensate for lens distortions and camera alignment errors. Stereo matching is then performed by applying a variation of the Semi Global Matching (SGM) algorithm as introduced by Hirschmüller (2005). Various post-processing methods are applied to improve the processing results. The output of the SVC is a subpixel accurate and dense disparity map, which is streamed over an AXI4-Stream interface.

To simplify the use of the SVC on devices with a shared system memory, such as the Xilinx Zynq SoC, an auxiliary core for direct memory access (DMA) is provided. This DMA core reads input data from memory through AXI3 and converts it into data streams that are suitable for the SVC. Likewise, the DMA core also collects the output data from the SVC and writes it back to memory.

Both IP cores are provided as encrypted RTL code. An IP block for both cores is available for Xilinx Vivado IP Integrator.

2 Features

The SVC and DMA core comprise the following features:

- General processing architecture
 - Processing of grayscale images with a bit depth of 8 bits per pixel
 - Stream-based processing of input images using either AXI4-Stream or AXI3
 - Configuration through AXI4-Lite interface
 - Output of disparity map starts before receiving the last pixel of both input images
 - Support for variable image sizes
 - Multi-clock design with faster clock for performance critical tasks
- Image rectification
 - Rectification using a pre-computed compressed rectification map
 - Bi-linear interpolation for subpixel accurate rectification
- Stereo matching
 - Stereo matching through a variation of the Semi-Global Matching (SGM) algorithm
 - Configurable disparity range from 32 to 256 pixels
 - Configurable disparity offset
 - Configurable penalties P_1 and P_2 for small and large disparity variations
 - Pre-processing of input images for improved robustness against illumination variations and occlusions

- Post-processing
 - Subpixel optimization
 - Consistency check with configurable threshold
 - Uniqueness check with configurable threshold
 - Filling of small gaps through interpolation
 - Noise reduction
 - Speckle filtering
 - Filtering of untextured image areas

3 Background

3.1 Camera Alignment

For stereo vision, both cameras have to be mounted on a plane with a displacement that is perpendicular to the cameras' optical axes. Furthermore, both cameras must be equipped with lenses that have an identical focal length. This arrangement is known as the *standard epipolar geometry*. An example for such a camera mounting is shown in Figure 1.

The distance between both cameras is referred to as *baseline distance*. Using a large baseline distance improves the depth resolution at high distances. A small baseline distances, on the other hand, allows for the observation of close objects. The baseline distance should be adjusted in conjunction with the lenses' focal length. An online tool for computing desirable combinations of baseline distance and focal length can be found on the Nerian Vision Technologies website¹.

3.2 Image Rectification

Even when carefully aligning both cameras, you are unlikely to receive images that match the expected result form an ideal standard epipolar geometry. The images are affected by various distortions that result from errors in the cameras' optics and mounting. Therefore, the first processing step that needs to be performed is an image undistortion operation, which is known as *image rectification*.

Figure 2a shows an example camera image, where the camera was pointed towards a calibration board. The edges of the board appear slightly bent, due to

¹<https://nerian.com/support/resources/calculator/>



Figure 1: Example for standard epipolar geometry.

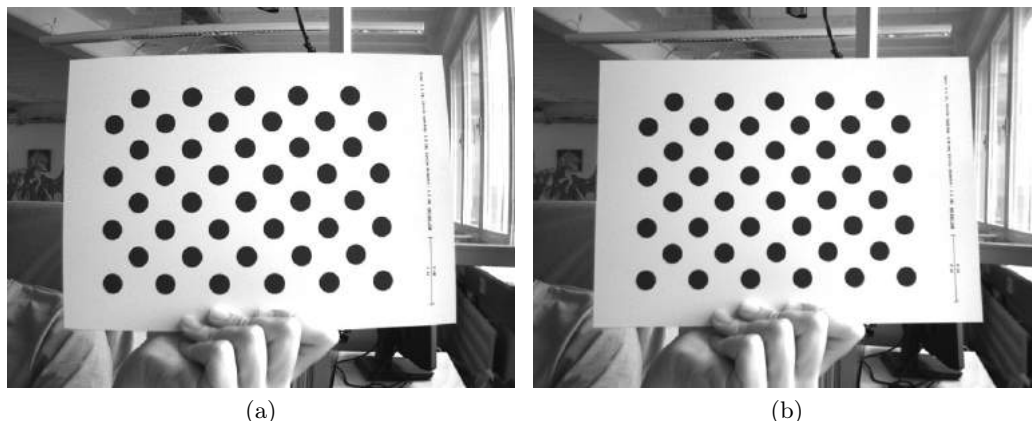

Figure 2: Example for (a) unrectified and (b) rectified camera image.

radial distortions caused by the camera’s optics. Figure 2b shows the same image after image rectification. This time, all edges of the calibration board are perfectly straight.

3.3 Camera Calibration

Image rectification requires precise knowledge of the cameras’ projective parameters, which is obtained through *camera calibration*. This typically requires the recording of several sample images of a flat calibration board with a visible calibration pattern. From the observed projection of this pattern it is then possible to compute the calibration parameters. This process is not implemented by the SVC, but has to be performed in software. Source code for computing the calibration parameters from a set of camera images is provided.

3.4 Disparity Maps

The stereo matching results are delivered by the SVC in the form of a *disparity map* from the perspective of the left camera. The disparity map associates each pixel in the left camera image with a corresponding pixel in the right camera image. Because both images were previously rectified to match an ideal standard epipolar geometry, corresponding pixels should only differ in their horizontal coordinates. The disparity map thus only encodes a *horizontal coordinate difference*.

An example for a left camera image and the corresponding disparity map are shown in Figures 3a and 3b. Here the disparity map has been color coded, with blue hues reflecting small disparities, and red hues reflecting large disparities. As can be seen, the disparity is proportional to the inverse depth of the corresponding scene point.

The *disparity range* specifies the image region that is searched for finding pixel correspondences. In the example image, the color legend indicates that the disparity range reaches from 0 to 111 pixels. A large disparity range allows for very accurate measurements, but causes a high computational load and thus lowers the achievable frame rate. The SVC supports a configurable disparity range, which provides a choice



Figure 3: Example for (a) left camera image and corresponding disparity map.

between high precision or high speed.

It is possible to transform the disparity map into a set of 3D points. This can be done at a correct metric scale if the cameras have been calibrated properly. The transformation of a disparity map to a set of 3D points requires knowledge of the disparity-to-depth mapping matrix Q , which can be computed during camera calibration. The 3D location $(x \ y \ z)^T$ of a point with image coordinates (u, v) and disparity d can be reconstructed as follows:

$$\begin{pmatrix} x \\ y \\ z \end{pmatrix} = \frac{1}{w} \cdot \begin{pmatrix} x' \\ y' \\ z' \end{pmatrix}, \text{ with } \begin{pmatrix} x' \\ y' \\ z' \\ w \end{pmatrix} = Q \cdot \begin{pmatrix} u \\ v \\ d \\ 1 \end{pmatrix}$$

An efficient implementation of this transformation is available in the API for the SP1 stereo vision system.

The SVC computes disparity maps with a disparity resolution that is below one pixel. Disparity maps have a bit-depth of 12 bits, with the lower 4 bits of each value representing the fractional disparity component. It is thus necessary to divide each value in the disparity map by 16 in order to receive the correct disparity magnitude.

Several post-processing techniques are applied in order to improve the quality of the disparity maps. Some of these methods detect erroneous disparities and mark them as invalid. Invalid disparities are set to 0xFF, which corresponds to the decimal value 255.9375 and is the maximum value that can be stored in the 12-bit disparity map. In Figure 3b invalid disparities have been depicted as black.

4 Stereo Vision Core Functionality

The overall functionality of the SVC is depicted in Figure 4. The port `register_io` provides read and write access to the device registers, which keep all processing parameters. This port complies to the AXI4-Lite standard (ARM, 2013) and acts as a communication slave. The port `frame_complete` provides a binary signal which is asserted to 1 for one clock cycle, once processing of the current frame has been completed.

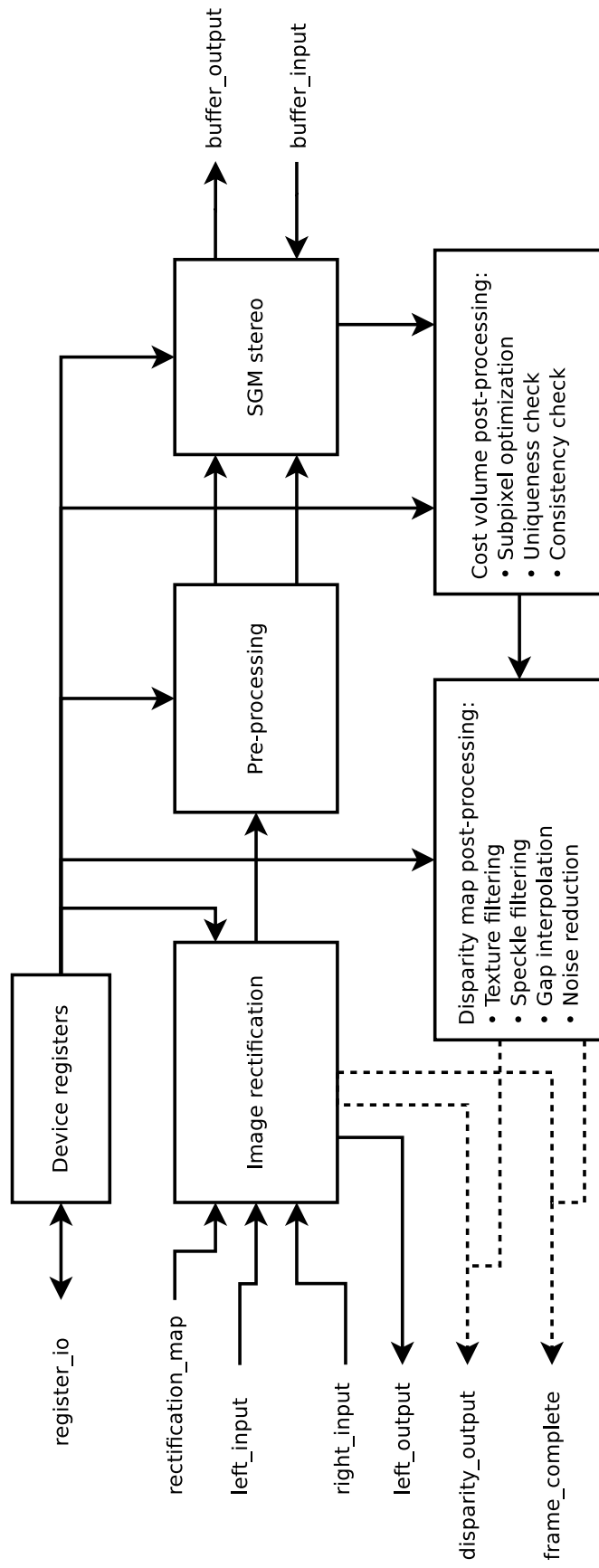

Figure 4: Block diagram of SVC functionality.

The remaining input and output ports implement the AXI4-Stream protocol (ARM, 2010) and read image data and image rectification maps, or read and write temporary buffer data. The purpose of each port and the involved processing is described in the subsequent sections.

Processing inside the SVC is divided into several sub-modules. Not all of these sub-modules are mandatory. Some can be deactivated through setting the appropriate device registers, or they can be removed from the IP core altogether if desired. A detailed description of each sub-module is provided below.

4.1 Rectification

The SVC concurrently reads two input images from the `left_input` and `right_input` ports. The first processing step that is applied to the input data is image rectification. To perform image rectification, a pre-computed rectification map is required that is read from the dedicated input port `rectification_map`. The rectification map contains a subpixel accurate x- and y-offset for each pixel of the left and right input images. Bi-linear interpolation is applied to map the subpixel offsets to image intensities.

The offsets are interleaved such that reading from a single data stream is sufficient for finding the displacement vector for each pixel in both images. To save bandwidth, the rectification map is stored in a compressed form. On average one byte is required for encoding the displacement vector for a single pixel. Hence, the overall size of the rectification map is equal to the size of two input images. Source code is provided for generating the rectification map from typical camera calibration parameters.

Rectification is a window-based operation. Hence, the pixel offsets are limited by the employed window size. In our default parameterization a window size of 79×79 pixels is used. This allows for offsets in the range of -39 to $+39$ pixels. If desired, the window size can be adjusted to allow for larger pixel displacements.

The left rectified image is always written to `left_output`. If desired, the right rectified image can be written to `disparity_output` by setting the appropriate operation mode in the SVC registers (see Section 11.2.1). When outputting the right rectified image, stereo matching results are not available. Furthermore, as the `disparity_output` port is intended for delivering 12 bit wide subpixel accurate disparities, it has a larger than needed data width. When delivering the right rectified image over this output, the least significant four bits, which otherwise correspond to the subpixel component of a disparity value, are set to 0.

4.2 Image Pre-Processing

An image pre-processing method is applied to both input images. This causes the subsequent processing steps to be more robust towards illumination variations and occlusions.

4.3 Stereo Matching

Stereo matching is performed by applying a variation of the SGM algorithm by Hirschmüller (2005). The penalties P_1 and P_2 that are employed by SGM for small

and large disparity variations can be configured at runtime through the SVC's registers.

The SVC requires several iterations for processing one pixel of the left input image. In each iteration, the left image pixel is compared to a group of pixels in the right image. The size of this group is determined through the parallelization parameter p (see Section 6). The number of iterations per left image pixel can be configured through registers.

A *disparity offset* o_d can also be configured through registers, which indicates the smallest disparity value that will be considered during stereo matching. If $o_d \neq 0$ then the observable depth range will have an upper limit, as disparities smaller than o_d will not be allowed. The disparity offset o_d , iteration count n_i and the parallelization p determine the maximum disparity d_{max} :

$$d_{max} = o_d + n_i p - 1 \quad (1)$$

For storing intermediate processing results, the SGM sub-module requires write access to an external buffer through the port `buffer_output`. This buffer can be located in external memory, or if desired in the FPGA's block RAM. The total size s_b of the buffer can be computed as follows:

$$s_b = 3 \cdot (d_{max} + 1) \cdot w_{max} , \quad (2)$$

where d_{max} is the maximum disparity and w_{max} is the maximum supported image width. For the default parameterization from Section 6, this buffer requires a total size of 600 KB.

Data is written linearly to the buffer, starting from byte offset 0 all the way through to the last byte in the buffer. Once the last byte has been written, the SVC sends out a rewind signal. Writing will then restart again at byte offset 0. Similarly, the content of the same buffer is read back linearly through the port `buffer_input`, and reading restarts at byte offset 0 upon a corresponding rewind signal. It is ensured that reading and writing will never happen simultaneously on the same buffer data.

4.4 Cost Volume Post-Processing

The SGM stereo algorithm produces a *cost volume*, which encodes the matching costs for all valid combinations of left and right image pixels. Several of the applied post-processing techniques operate directly on this cost volume.

4.4.1 Subpixel Optimization

Subpixel optimization is the first applied post-processing technique. This step increases the accuracy of depth measurements by evaluating the matching costs to the left and right of the detected minimum for each pixel. A curve is fitted to the matching costs and its minimum is determined with subpixel accuracy.

The improved disparity estimates are then encoded as fixed point numbers. Currently the SVC supports 4 decimal bits for the subpixel optimized disparity. Hence, it is possible to measure disparities with a resolution of 1/16 pixel. It is thus required to divide each disparity value by 16, when interpreting the final disparity map.

4.4.2 Uniqueness Check

Matches with a high matching uncertainty are discarded by imposing a uniqueness constraint. For a stereo match to be considered unique, the minimum matching cost c_{min} times a uniqueness factor $q \in [1, \infty)$ must be smaller than the cost for the next best match. This relation can be expressed in the following formula, where C is the set of matching costs for all valid pixel pairs and $c^* = c_{min}$ is the cost for the best match:

$$c^* \cdot q < \min \{C \setminus \{c_{min}\}\}. \quad (3)$$

Stereo matches that are discarded through the uniqueness check are assigned a disparity label of 0xFFFF.

4.4.3 Consistency Check

A consistency check is employed for removing further matches with high matching uncertainties. The common approach to this post-processing technique is to repeat stereo matching in the opposite matching direction (in our case from the right image to the left image), and then only retaining matches for which

$$|d_l - d_r| \leq t_c, \quad (4)$$

where d_l is the disparity from left-to-right matching, d_r the disparity from right-to-left matching, and t_c is the consistency check threshold.

In order to save FPGA resources, we refrain from re-running stereo matching a second time in the opposite matching direction. Rather, the right camera disparity map is inferred from the matching costs that have been gathered during the initial left-to-right stereo matching. Pixels that do not pass the consistency check are again labeled with 0xFFFF.

4.5 Disparity Map Post-Processing

Following the cost volume post-processing, the cost volume is reduced to a disparity map (see Section 3.4). Additional post processing methods are then applied directly to the disparity values.

4.5.1 Texture Filtering

Matching image regions with little to no texture is particularly challenging. Especially if such regions occur close to image borders, this might lead to significant mismatches. In order to address this problem, a texture filter is applied. This filter computes a texture score s_t for each image pixel, which reflects the texture intensity within a local neighborhood. Pixels for which this score is below a configurable threshold t_t are again labeled with 0xFFFF in the computed disparity map.

4.5.2 Speckle Filtering

The aforementioned methods are not always able to identify and label all erroneous matches. Fortunately, the erroneous matches that remain tend to appear as small clusters of similar disparity. These *speckles* are then removed with a speckle filter.

The speckle filter identifies connected components that are below a specified minimum size. The minimum speckle size is controlled through the speckle filter window size w_s , which is an IP core internal parameter. The pixels that belong to identified speckles are again labeled with 0xFFF.

4.5.3 Gap Interpolation

The aforementioned post-processing techniques all remove pixels from the computed disparity map, which leaves gaps with no valid disparity data. If one such gap is small, it can be filled with valid disparities by interpolating the disparities from its edges. Interpolation is only performed for gaps whose vertical and horizontal extent l_h and l_v fulfill the condition

$$\min \{l_h, l_v\} \leq l_{max}, \quad (5)$$

where l_{max} is the maximum gap width. Interpolation is also omitted if the disparities from the edge of the identified gap do not have a similar magnitude.

4.5.4 Noise Reduction

Finally, a noise reduction filter is applied to the generated disparity map. This filter performs a smoothing of the disparity map, while being aware of discontinuities and invalid disparities. If the operation mode is set to stereo matching (see Section 11.2.1), then the disparity map that results after this filter is directly written to the `disparity_output` port.

5 DMA Core Functionality

When using the SVC directly it is in the responsibility of the developer to provide all required data on the input ports and to collect the data from the output ports in time. In a typical setting, the input data is read from off-chip memory and the processing results are written back to memory. For systems with a shared system memory, such as the Zynq SoC, we provide a DMA core for fetching and writing data. The functionality of this core is depicted in the block diagram of Figure 5.

5.1 Ports Connected to SVC

Except for the clock signals, the DMA core connects to all input and output ports of the SVC. In Figure 5, those ports are depicted on the right. The ports match the ones shown in Figure 4 on page 7, plus one further output and two inputs that were omitted previously for simplicity.

The new output is `system_resetn`, which is an active low reset signal. The reset signal is set to 0 if either the DMA core is reset itself, or if a soft reset is triggered through writing to the reset-bit in register 0x00. It is recommended that the SVC's reset input is connected to this output. Otherwise, the SVC will not be affected by a soft reset of the DMA core, which can lead to erroneous behavior.

The new SVC-specific input ports are `buffer_input_rewind` and `buffer_output_rewind`. These binary signals are asserted by the SVC when reading from or writing to the buffer memory shall restart from the beginning. It is important that reading

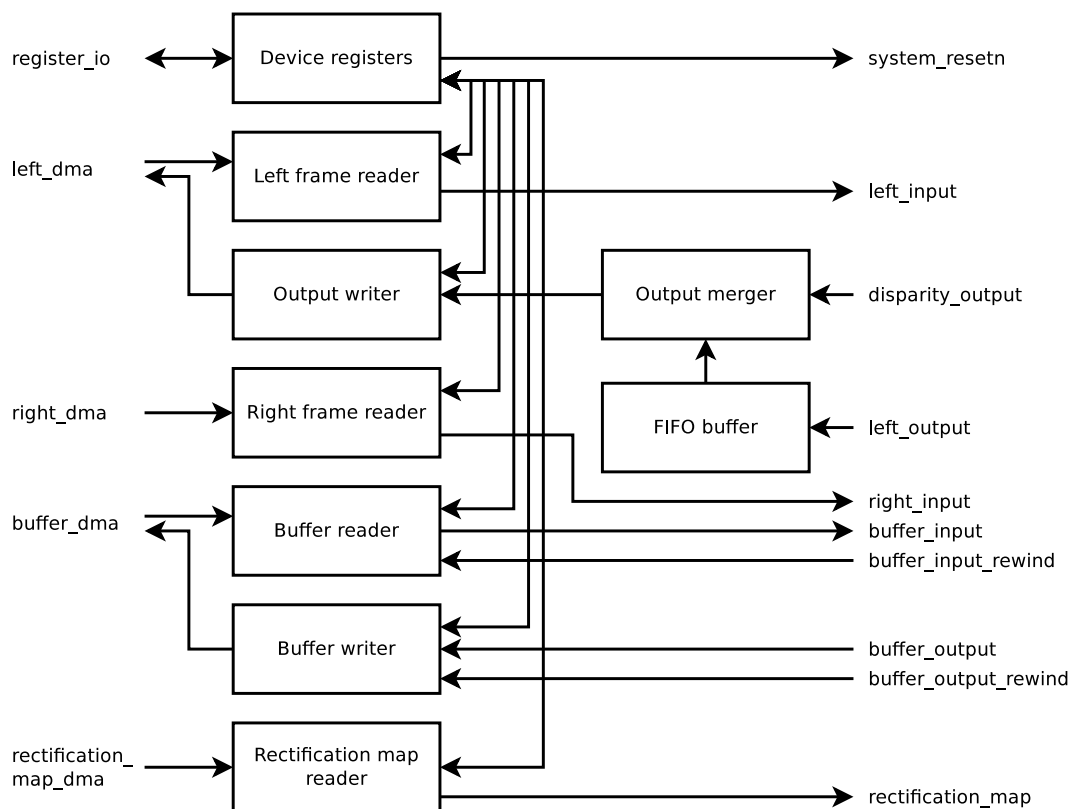

Figure 5: Block diagram of DMA core functionality.

does not start before this signal is asserted, as the relevant data might not yet have been written.

5.2 Interface Ports

All ports that are not connected to the SVC appear on the left hand side of Figure 5. The port `register_io` provides read and write access to all device registers of the DMA core. This port complies to the AXI4-Lite standard (ARM, 2013) and acts as a communication slave.

The remaining ports follow the AXI3 standard (ARM, 2013) and act as communication masters. The `left_dma` port fetches the left input image and is also used for delivering the processing results. Similarly, the `right_dma` port is used for fetching the right input image. The port `buffer_dma` serves for reading from and writing to the buffer memory and the `rectification_map_dma` port is used for fetching the rectification map.

All fetch and write operations of the AXI3 ports are controlled through the device registers. They contain the input and output memory addresses and can trigger reading or writing operations when set to a new value. More details on the device registers can be found in Section 11 on page 22.

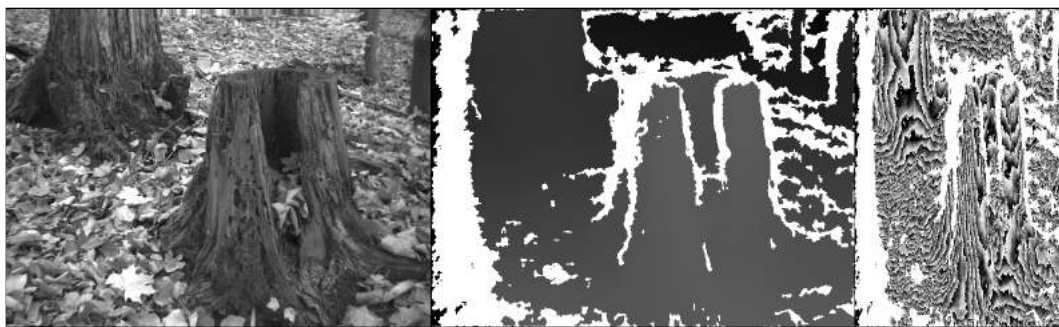

Figure 6: Example for interpreting the merged output as image when splitting the disparity map.

5.3 Output Conversion

The rectified left image and the disparity map that are output by the SVC are merged into a single data stream by the DMA core. This data stream is then output over the `left_dma` port. Because the disparity map is computed with a significantly higher delay than the rectified left image, the DMA core contains a sufficiently sized FIFO buffer for buffering the rectified left image data. For merging the two incoming data streams, the DMA core provides two possible options.

5.3.1 Split Disparity Map

In the first option the disparities are split into an 8-bit integer component and a 4-bit subpixel component, which consists of the disparity decimal bits (see Section 4.4.1). We hence receive two new maps, which are the *integer disparity map* and the *subpixel component map*.

An image row of the left rectified image, a row of the integer disparity map and a row of the subpixel component map are then output consecutively over the `left_dma` port. This interleaved output is repeated until there are no more remaining rows to be delivered.

It has to be considered that an element of the subpixel component map only has a size of 4-bits. Hence, two consecutive values are combined into a single byte. For this operation the first 4-bit element is written to the less-significant 4 bits, and the second element is written to the more-significant 4 bits of the 8-bit output value.

The merged output data can be interpreted as a row-wise sampled image with dimensions $2.5w \times h$, where w and h are the width and height of the input image. An example for the output of the DMA core when interpreted this way is shown in Figure 6. As can be seen, the output image is a horizontal arrangement of the left rectified image, the integer disparity map and the subpixel component map.

5.3.2 Extended Disparities

The alternative method for merging the SVC output is to not split the disparities into integer and subpixel components. Rather, the disparities are extended to 16 bits. This happens by introducing additional high-significant bits, which are set to 0.

The output is then again a row-wise interleaving of the left rectified image and the 16-bit extended disparity map. Compared to the first output option, this method produces more data due to the disparity extension. In total, the data that is delivered over the `left_dma` port is equivalent to a $3w \times h$ sized image.

6 Parameterization

Both, the SVC and the DMA core can be customized through several parameters. In Vivado's IP Integrator, these parameters can be set through the customization GUI. Screenshots of the customization windows for the SVC and DMA core are provided in Figures 7 and 8. Further parameters might be available for modification upon request. Please contact us if you have any special requirements.

6.1 SVC Parameters

The SVC provides the customization parameters listed below. For each parameter a default value is provided, which we recommend and use in our own products. All performance indicators that are provided in this document have been obtained with this default parameterization.

Maximum image width: Maximum allowed width w_{max} of an input image. The actual image width is configured through the SVC registers and can be smaller (see Section 11.2.2). This parameter has a significant impact on the block RAM usage. The value must be a multiple of $2 \times$ the number of pixels processed in parallel p . Default value: 800.

Maximum image height: Maximum allowed height h_{max} of an input image. The actual image height is configured through the SVC registers and can be smaller (see Section 11.2.2). This parameter only has a small impact on the resource usage. The value must be a multiple of the internal buffer size. Default value: 2400.

Number of pixels processed in parallel: The number of pixels p that are compared in parallel during SGM stereo matching. Together with the number of iterations, this parameter defines the disparity range (see Section 4.3). This parameter has a significant impact on the LUT usage. Default value: 16.

Maximum number of iterations per pixel: SGM stereo matching requires several iterations for processing a single pixel of the left input image (see Section 4.3). This parameter defines the maximum number of iterations that are allowed to be performed. Together the number of iterations and number of pixels processed in parallel define the disparity range. A lower number of iterations can be configured at runtime by writing to the SVC's registers (see Section 11.2.1)

Disparity width: The bit width of the output disparity map. This value must be large enough to allow for an output of the maximum disparity for the current parameterization. Please keep in mind that the disparities contain a 4-bit subpixel component (see Section 3.4). Default value: 12.

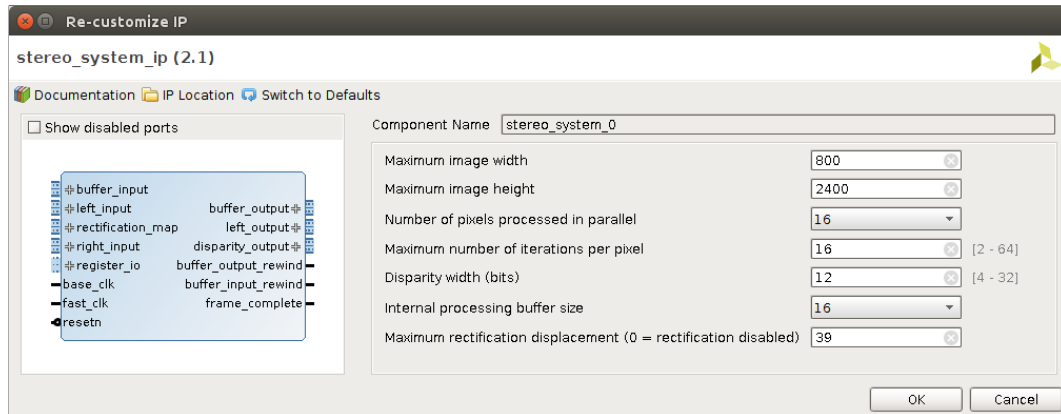

Figure 7: Configuration parameters of SVC.

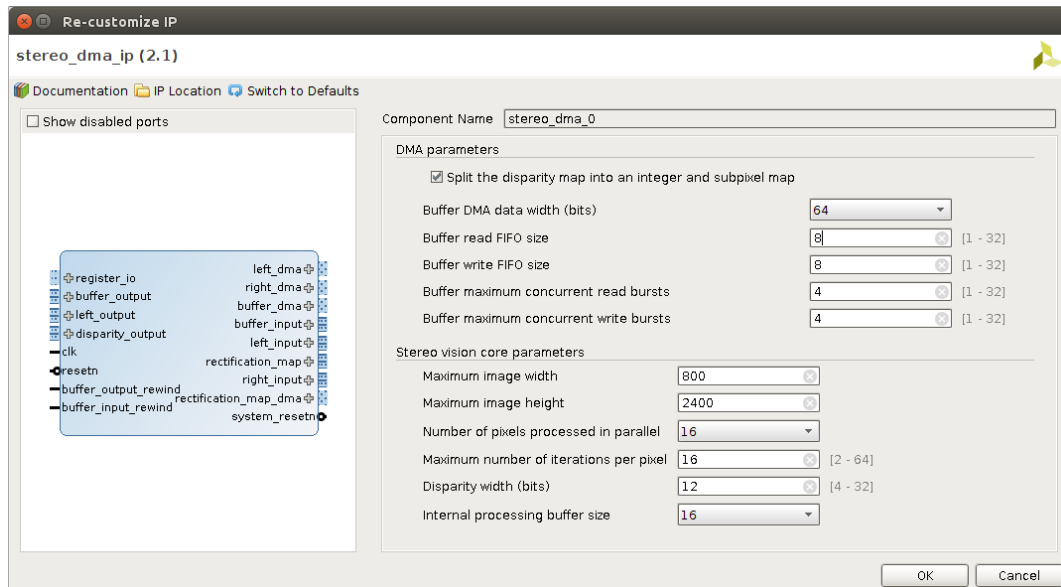

Figure 8: Configuration parameters of DMA core.

Internal processing buffer size: Size of an internal buffer that is used by SGM stereo matching for caching computation results. This parameter has a high impact on the LUT and block RAM usage. Increasing this parameter significantly reduces the bandwidth that is required for reading from / writing to the external buffer. Default value: 16.

Maximum rectification displacement: The maximum offset that a pixel can be moved in vertical or horizontal direction during image rectification (see Section 4.1). This parameter has a significant impact on the block RAM usage. If a value of 0 is provided, then image rectification is disabled. Please note that the provided rectification map must be computed with respect to this parameter. Default value: 39.

6.2 DMA Core Parameters

Most of the SVC customization parameters are also available in the DMA core. It is important that these common parameters are configured identically in both cores. On top of the SVC parameters, the DMA core also provides its own customization parameters, which are:

Split disparity map into integer and subpixel map: As described in Section 5.3, the DMA core provides two possible modes for outputting the disparity map. If this parameter is true, then the subpixel accurate disparity values are split into an integer and a subpixel component, which are output separately. If this parameter is false, then the disparity values are extended to 16 bits and output without splitting. Default value: true.

Buffer DMA data width: Width in bits of a data word for the `buffer_dma` port. This port will be subject to high bandwidth data transfers. It should thus be configured to the highest data width that is supported by the external memory. Default value: 64.

Buffer read FIFO size: Size of the FIFO buffer that is attached to the read channel of the `buffer_dma` port, measured in data words. Default value: 8.

Buffer write FIFO size: Size of the FIFO buffer that is attached to the write channel of the `buffer_dma` port, measured in data words. Default value: 8.

Buffer maximum concurrent read bursts: Maximum allowed number of outstanding read bursts for the `buffer_dma` port. Increasing this value will increase the read throughput. Default value: 4.

Buffer maximum concurrent write bursts: Maximum allowed number of outstanding write bursts for the `buffer_dma` port. Increasing this value will increase the write throughput. Default value: 4.

7 Supported Devices

The SVC has been field-tested on the Zynq 7000 SoC. We thus recommend using this FPGA family. However, our IP core is also compatible to other Xilinx 7-Series FPGAs. Please contact us to find out if your desired device is supported.

Table 1: SVC processing delays for default parameterization when processing input images of size 640×480 pixels and 112 disparity levels.

| Delay | Base clock cycles | Time |
|--------------------------|-------------------|----------|
| Delay until first output | 103,000 | 1.03 ms |
| Delay until last output | 1,856,000 | 18.56 ms |

8 Timing

The SVC has been implemented as a multi-clock design. All input and output signals are associated with the *base clock*. When synthesized for the Zynq 7000 SoC with speed grade 1, this clock can have a frequency of up to 100 MHz. In addition to the base clock, the SVC uses the so-called *fast clock* for clocking particularly performance critical tasks. For the given Zynq SoC, this clock can have a frequency of up to 143 MHz. The IP core will add a false path constraint between both clock domains.

If the DMA core is employed, its clock input has to be connected to the base clock. The maximum clock speed of the base clock matches the clock speed for the Zynq’s Static Memory Controller (SMC). Hence, the DMA core can be directly connected to the Zynq’s memory interfaces.

The expected SVC processing delays when processing an input image of resolution 640×480 pixels with the default parameterization from Section 6 and 7 iterations per pixel (i.e. 112 disparity levels) are listed in Table 1. The delays are given for a 100 MHz base clock and a 143 MHz fast clock, and are measured from the moment at which the first data item arrives at the SVC. As first output we consider the first byte of the computed disparity map. Consequently, the last output is the last byte of the disparity map, after which processing is complete.

The measurements were determined under the assumption that new data is always available at the SVCs inputs. If the data to be processed is read from system memory, higher delays might occur due to the additional memory delays.

9 Resource Usage

The total resource usage of the SVC and DMA core is listed in Table 2. The table further contains resource usage information for the individual sub-modules that have been identified in Section 4. These numbers provide an overview of the gains that can be achieved when removing one of the sub-modules from the SVC.

10 IO Signals

Figures 9a and 9b contain a depiction of the SVC and DMA core as they appear in IP Integrator, which is part of Xilinx Vivado. Most of the shown ports have already been described in Sections 4 and 5. A detailed list of all input and output signals, including a breakdown of the AXI ports, is provided in Table 3 for the SVC. Likewise, Table 4 contains an equivalent list for the DMA core.

Table 2: Resource usage of SVC and individual sub-modules.

| Description | Slice LUTs | Registers | Memory | DSPs |
|-----------------------|------------|-----------|--------|------|
| SVC total usage | 26,445 | 28,524 | 103.0 | 29 |
| DMA core total usage | 3,151 | 3,477 | 4.0 | 4 |
| Image rectification | 1,755 | 1,699 | 34.0 | 10 |
| Image pre-processing | 363 | 829 | 3.0 | 2 |
| SGM stereo | 11,581 | 17,443 | 47.0 | 7 |
| Subpixel optimization | 490 | 413 | 0.0 | 0 |
| Uniqueness check | 800 | 494 | 0.0 | 1 |
| Consistency check | 3,860 | 1,337 | 1.0 | 0 |
| Texture filter | 299 | 573 | 9.5 | 1 |
| Speckle filter | 4,505 | 2,659 | 3.5 | 1 |
| Gap interpolation | 1,070 | 1,287 | 4.0 | 6 |
| Noise suppression | 848 | 1,134 | 1.0 | 1 |
| Others | 874 | 656 | 0.0 | 0 |

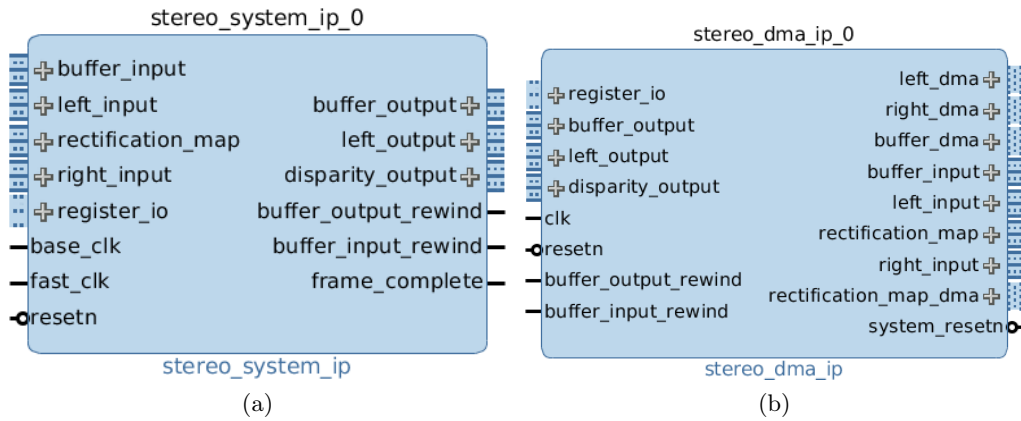

Figure 9: Interfaces of (a) SVC and (b) DMA core as shown by IP Integrator.

Table 3: List of SVC input and output signals..

| Signal name | i/o | Bits | Description |
|---------------------------------------|-----|------|--|
| base_clk | i | 1 | Base clock source; this is the relevant clock for all input and output signals (see Section 8) |
| fast_clk | i | 1 | A faster clock for performance critical tasks (see Section 8) |
| resetsn | i | 1 | Global reset signal; active low |
| frame_complete | o | 1 | Signals that processing of the current frame has finished (see Section 4) |
| register_io signals | | | |
| register_io_araddr | i | 32 | Read address |
| register_io_arprot | i | 3 | Protection type; ignored! |
| register_io_arready | o | 1 | Read address ready; always 1! |
| register_io_arvalid | i | 1 | Read address valid |
| register_io_awaddr | i | 32 | Write address |
| register_io_awprot | i | 3 | Protection type; ignored! |
| register_io_awready | o | 1 | Write address ready; always 1! |
| register_io_awvalid | i | 1 | Write address valid |
| register_io_bready | i | 1 | Response ready |
| register_io_bresp | o | 2 | Write response; always 00 ₂ (OK)! |
| register_io_bvalid | o | 1 | Write response valid |
| register_io_rdata | o | 32 | Read data |
| register_io_rready | i | 1 | Read ready |
| register_io_rresp | o | 2 | Read response; always 00 ₂ (OK)! |
| register_io_rvalid | o | 1 | Read valid |
| register_io_wdata | i | 32 | Write data |
| register_io_wready | o | 1 | Write ready |
| register_io_wstrb | i | 4 | Write strobes; ignored! |
| register_io_wvalid | i | 1 | Write valid |
| Signals for AXI4-Stream inputs | | | |
| left_input_tready | o | 1 | Ready to receive left image |
| left_input_tvalid | i | 1 | Left image data is valid |
| left_input_tdata | i | 8 | Left image data |
| right_input_tready | o | 1 | Ready to receive right image |
| right_input_tvalid | i | 1 | Right image data is valid |
| right_input_tdata | i | 8 | Right image data |
| rectification_map_tready | o | 1 | Ready to receive rectification map |
| rectification_map_tvalid | i | 1 | Rectification map data is valid |
| rectification_map_tdata | i | 32 | Rectification map data |
| buffer_input_rewind | o | 1 | Reading from buffer shall restart from offset 0 (see Sections 4.3 and 5.1) |
| buffer_input_tready | o | 1 | Ready to receive buffer input |
| buffer_input_tvalid | i | 1 | Buffer input data is valid |

| | | | |
|--------------------|---|------|-------------------|
| buffer_input_tdata | i | 384* | Buffer input data |
|--------------------|---|------|-------------------|

Signals for AXI4-Stream outputs

| | | | |
|-------------------------|---|------|--|
| left_output_tready | i | 1 | Ready to deliver left output |
| left_output_tvalid | o | 1 | Left output data is valid |
| left_output_tdata | o | 8 | Left output data |
| disparity_output_tready | i | 1 | Ready to deliver disparity output |
| disparity_output_tvalid | o | 1 | Disparity output data is valid |
| disparity_output_tdata | o | 11* | Disparity output data |
| buffer_output_rewind | o | 1 | Writing to buffer shall restart from offset 0 (see Sections 4.3 and 5.1) |
| buffer_output_tready | i | 1 | Ready to deliver buffer output |
| buffer_output_tvalid | o | 1 | Buffer output data is valid |
| buffer_output_tdata | o | 384* | Buffer output data |

* Size given for default parameterization.

Table 4: List of DMA core input and output signals.

| Signal name | i/o | Bits | Description |
|-------------|-----|------|---|
| clk | i | 1 | Main clock source; has to match the base clock from SVC |
| resetsn | i | 1 | Global reset signal; active low |

register_io signals

| | | | |
|---------------------|---|----|--|
| register_io_araddr | i | 32 | Read address |
| register_io_arprot | i | 3 | Protection type; ignored! |
| register_io_arready | o | 1 | Read address ready; always 1! |
| register_io_arvalid | i | 1 | Read address valid |
| register_io_awaddr | i | 32 | Write address |
| register_io_awprot | i | 3 | Protection type; ignored! |
| register_io_awready | o | 1 | Write address ready; always 1! |
| register_io_awvalid | i | 1 | Write address valid |
| register_io_bready | i | 1 | Response ready |
| register_io_bresp | o | 2 | Write response; always 00 ₂ (OK)! |
| register_io_bvalid | o | 1 | Write response valid |
| register_io_rdata | o | 32 | Read data |
| register_io_rready | i | 1 | Read ready |
| register_io_rresp | o | 2 | Read response; always 00 ₂ (OK)! |
| register_io_rvalid | o | 1 | Read valid |
| register_io_wdata | i | 32 | Write data |
| register_io_wready | o | 1 | Write ready |
| register_io_wstrb | i | 4 | Write strobes; ignored! |
| register_io_wvalid | i | 1 | Write valid |

buffer_io / left_io / right_io / rect_map signals

| | | | |
|----------|---|----|--------------|
| *_araddr | o | 32 | Read address |
|----------|---|----|--------------|

| | | | |
|-----------|---|----|--|
| *_arburst | o | 2 | Read burst type; always 01 ₂ (INCR)! |
| *_arcache | o | 4 | Read memory type; always 0011 ₂ (normal, non-cacheable, bufferable)! |
| *_arlen | o | 4 | Read burst length; always 1111 ₂ (16 transfers)! |
| *_arlock | o | 2 | Read lock type; always 00 ₂ (normal acces)! |
| *_arprot | o | 3 | Read protection type; always 000 ₂ (unprivileged secure data)! |
| *_arqos | o | 4 | Read quality of service; always 0000 ₂ ! |
| *_arready | i | 1 | Read ready |
| *_arsize | o | 3 | Read burst size; always 011 ₂ (8 bytes)! |
| *_arvalid | o | 1 | Read valid |
| *_awaddr | o | 32 | Write address |
| *_awburst | o | 2 | Write burst type; always 01 ₂ (INCR)! |
| *_awcache | o | 4 | Write memory type; always 0011 ₂ (normal, non-cacheable, bufferable)! |
| *_awlen | o | 4 | Write burst length; always 1111 ₂ (16 transfers)! |
| *_awlock | o | 2 | Write lock type; always 00 ₂ (normal acces)! |
| *_awprot | o | 3 | Write protection type; always 000 ₂ (unprivileged secure data)! |
| *_awqos | o | 4 | Write quality of service; always 0000 ₂ ! |
| *_awready | i | 1 | Write address ready |
| *_awsize | o | 3 | Write burst size; always 011 ₂ (8 bytes)! |
| *_awvalid | o | 1 | Write address valid |
| *_bready | o | 1 | Write response ready; always 1! |
| *_bresp | i | 2 | Write response; ignored! |
| *_bvalid | i | 1 | Write response valid |
| *_rdata | i | 64 | Read data |
| *_rlast | i | 1 | Read last |
| *_rready | o | 1 | Read ready |
| *_rresp | i | 2 | Read response; ignored! |
| *_rvalid | i | 1 | Read last |
| *_wdata | o | 64 | Write data |
| *_wlast | o | 1 | Write last |
| *_wready | i | 1 | Write ready |
| *_wstrb | o | 8 | Write strobes; always 11111111 ₂ ! |
| *_wvalid | o | 1 | Write valid |

left_input / right_input / rectification_map / buffer_input signals

| | | | |
|---------|---|--------|-----------------------------|
| *_ready | i | 1 | Ready to deliver input data |
| *_valid | o | 1 | Input data valid |
| *_data | o | varied | Data directed to SVC |

left_output / disparity_output / buffer_output signals

| | | | |
|---------|---|---|------------------------------|
| *_ready | o | 1 | Ready to receive output data |
| *_valid | i | 1 | Output data is valid |

| | | | | | | |
|--------|--|---|--|--------|--|------------------------|
| *_data | | i | | varied | | Data received from SVC |
|--------|--|---|--|--------|--|------------------------|

Other signals directed to SVC

| | | | | | | |
|---------------|--|---|--|---|--|---|
| system_resetn | | o | | 1 | | Active-low reset signal for SVC (see Section 5.1) |
|---------------|--|---|--|---|--|---|

11 Registers

The SVC and DMA core each hold several registers that control the device behavior and provide information about the internal device state. Both IP cores have their own address spaces, starting at address 0x00. Please note that only the least significant address bits are evaluated and that reading from / writing to higher addresses will still affect the device registers.

A complete list of all available registers is shown in Table 5 for the SVC, and in Table 6 for the DMA core. All registers that have been marked with *r* are read-only. Writing to these registers will not produce an error but the new data is ignored.

Each register has a size of 32 bits. To simplify access from a CPU, the register addresses are always multiples of 4. Read and write operations must always be aligned to a 4-byte boundary. Reading from or writing to an address that is not a multiple of 4 is disallowed and has an undefined outcome. In the following, a description of all SVC and DMA core registers is provided, sorted by register address.

11.1 DMA Core Registers

11.1.1 0x00: Control

General parameters that control the behavior of the SVC.

| | | | | | | | | | | | | | | | | | | | | | | | | | | | | | | | |
|----------|----|----|----|----|----|----|----|----|----|----|----|----|----|----|----|------------|----|----|----|----|----|----------|---|---|---|---|---|---|---|---|---|
| 31 | 30 | 29 | 28 | 27 | 26 | 25 | 24 | 23 | 22 | 21 | 20 | 19 | 18 | 17 | 16 | 15 | 14 | 13 | 12 | 11 | 10 | 9 | 8 | 7 | 6 | 5 | 4 | 3 | 2 | 1 | 0 |
| Reserved | | | | | | | | | | | | | | | | Iterations | | | | | | Reserved | | | | | R | | | | |

R If set to 1 then the device performs a soft reset.

Iterations Number of iterations per pixel (see Section 4.3). Must match the the SVC configuration. Default value is the maximum number of iterations from the customization parameters (see Section 6.2). Minimum allowed value is 2.

11.1.2 0x04: Status

General device status information.

| | | | | | | | | | | | | | | | | | | | | | | | | | | | | | | | |
|----------|----|----|----|----|----|----|----|----|----|----|----|----|----|----|----|----|----|----|----|----|----|---|---|----|----|---|----|----|----|---|---|
| 31 | 30 | 29 | 28 | 27 | 26 | 25 | 24 | 23 | 22 | 21 | 20 | 19 | 18 | 17 | 16 | 15 | 14 | 13 | 12 | 11 | 10 | 9 | 8 | 7 | 6 | 5 | 4 | 3 | 2 | 1 | 0 |
| Reserved | | | | | | | | | | | | | | | | | | | | | | | | BR | BW | M | RR | LR | LW | R | |

R If 0 then the device is currently performing a soft or hard reset.

LW If 1 then writing to `left_dma` has finished.

LR If 1 then reading from `left_dma` has finished.

RR If 1 then reading from `right_dma` has finished.

Table 5: Address space for SVC registers.

| Address | Name | Read/Write |
|---------|----------------------------|------------|
| 0x00 | Control | r/w |
| 0x04 | Image size | r/w |
| 0x08 | Algorithm parameters 1 | r/w |
| 0x0C | Algorithm parameters 2 | r/w |
| 0x10 | License key higher 32 bits | r/w |
| 0x14 | License key lower 32 bits | r/w |
| 0x18 | Device DNA higher 25 bits | r |
| 0x1C | Device DNA lower 32 bits | r |

Table 6: Address space for DMA registers.

| Address | Name | Read/Write |
|---------|-----------------------------|------------|
| 0x00 | Control | r/w |
| 0x04 | Status | r |
| 0x08 | Image size | r/w |
| 0x0C | Output address | r/w |
| 0x10 | Output bytes available | r |
| 0x14 | Output FIFO info | r |
| 0x18 | Left input address | r/w |
| 0x1C | Left input bytes available | r/w |
| 0x20 | Right input address | r/w |
| 0x24 | Right input bytes available | r/w |
| 0x28 | Input FIFO info | r |
| 0x2C | Rectification map address | r/w |
| 0x30 | Rectification map FIFO info | r |
| 0x34 | Buffer address | r/w |
| 0x38 | Buffer FIFO info | r |

M If 1 then reading from `rectification_map_dma` has finished.

BW If 1 then writing to `buffer_dma` has finished.

BR If 1 then reading from `buffer_dma` has finished.

11.1.3 0x08: Image Size

Dimensions of the left and right input images.

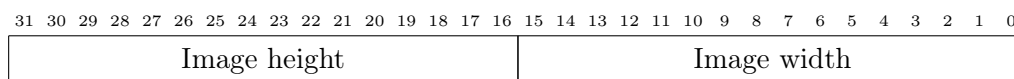
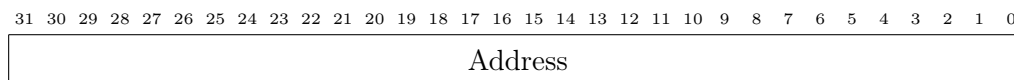

Image width Width of an input image. This must match the parameterization of the SVC core. The image width must be a multiple of $2\times$ the number of pixels processed in parallel (see Section 6.1). Default value: 0.

Image height Height of an input image. This must match the parameterization of the SVC core. The image height must be a multiple of the internal processing buffer size (see Section 6.1). Default value: 0.

11.1.4 0x0C: Output Address

Write address for `left_dma`. Writing ends once one full frame has been written to memory.



11.1.5 0x10: Output Bytes Available

The number of bytes that have successfully been written to `left_dma` since the start of the current frame.

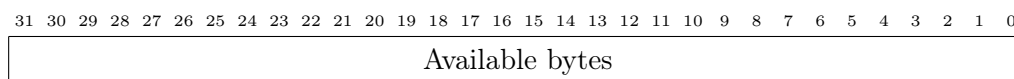

11.1.6 0x14: Output FIFO Info

Statistics for the output FIFO buffer that is attached to `left_dma`. The counter is reset with every new frame.

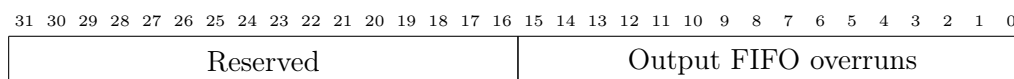

11.1.7 0x18: Left Input Address

Read address for `left_dma`. Reading from this address begins immediately after this register has been written. Reading continues until one full frame has been read from memory.

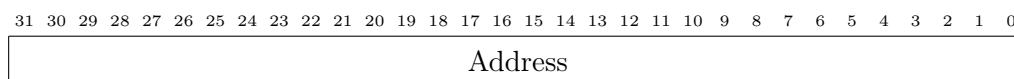

11.1.8 0x1C: Left Input Bytes Available

The number of bytes that can currently be read from `left_dma`, starting at the left input address. If this number is smaller than the frame size then reading will pause once the specified number of bytes have been read. In this case reading will continue once a higher value is written to this register.

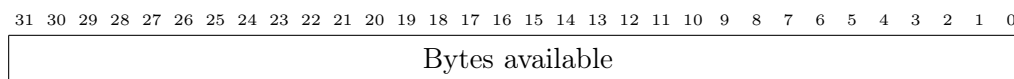
**11.1.9 0x20: Right Input Address**

Read address for `right_dma`. Reading from this address begins immediately after this register has been written. Reading continues until one full frame has been read from memory.

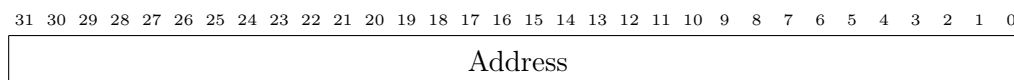
**11.1.10 0x24: Right Input Bytes Available**

The number of bytes that can currently be read from `right_dma`, starting at the right input address. If this number is smaller than the frame size then reading will pause once the specified number of bytes have been read. In this case reading will continue once a higher value is written to this register.

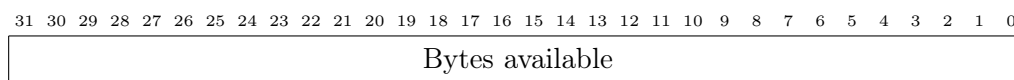
**11.1.11 0x28: Input FIFO Info**

Statistics for the input FIFO buffers that are attached to `left_dma` and `right_dma`. Counters are reset with every new frame.

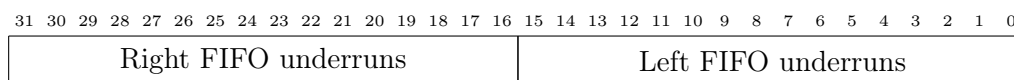
**11.1.12 0x2C: Rectification Map Address**

Read address for `rectification_map_dma`. Reading from this address begins immediately after this register has been written. Reading continues until the full rectification map has been read from memory.

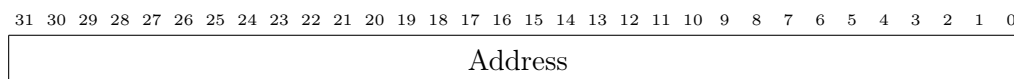
**11.1.13 0x30: Rectification Map FIFO Info**

Statistics for the rectification map FIFO buffer that is attached to `rectification_map_dma`. Counter is reset with every new frame.

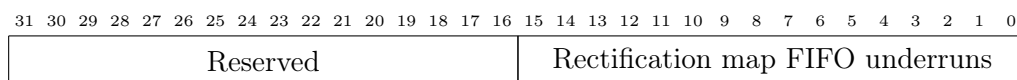

11.1.14 0x34: Buffer Address

Memory address for `buffer_io`. This address is used for both, reading and writing data.

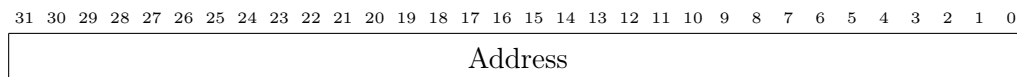

11.1.15 0x38: Buffer FIFO Info

Statistics for the FIFO buffers that are attached to `buffer_dma`. Counters are reset with every new frame.

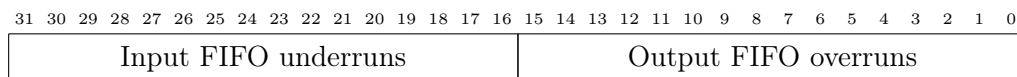

11.2 SVC Registers

11.2.1 0x00: Control

General parameters that control the behavior of the SVC.

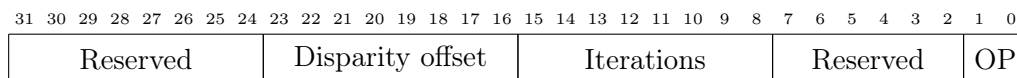

OP Operation mode. Possible values are:

- 00** Pass through. The SVC's left input is passed directly to the left output, and the right input is passed to the disparity output.
- 01** Rectify. The rectification results are passed directly to the SVC's left and right output.
- 10** Stereo matching (default). Stereo matching results are written to the SVC's disparity output, and the left rectified image is written to the left output.
- 11** Reserved

Iterations Number of iterations per pixel (see Section 4.3). Must match the the DMA core configuration. Default value is the maximum number of iterations from the customization parameters (see Section 6.1). Minimum allowed value is 2.

Disparity offset Offset for the disparity range in pixels (see Section 4.3). Default value: 0.

11.2.2 0x04: Image Size

Dimensions of the left and right input images.

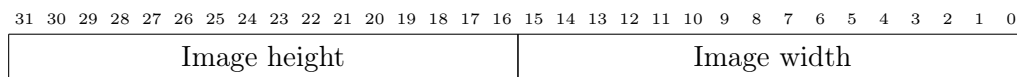

Image width Width of an input image. This must match the parameterization of the DMA core. The image width must be a multiple of $2 \times$ the number of pixels processed in parallel (see Section 6.1). Default value: 0.

Image height Height of an input image. This must match the parameterization of the DMA core. The image height must be a multiple of the internal processing buffer size (see Section 6.1). Default value: 0.

11.2.3 0x08: Algorithm Parameters 1

Algorithmic parameters that can be changed at run-time.

| | | | | | | | | | | | | | | | | | | | | | | | | | | | | | | | |
|----------|----|----------|----|-------------------|----|----|----|----|----|----|----|----------------|----|----|----|----------------|----|----|----|----|----|---|---|---|---|---|---|---|---|---|---|
| 31 | 30 | 29 | 28 | 27 | 26 | 25 | 24 | 23 | 22 | 21 | 20 | 19 | 18 | 17 | 16 | 15 | 14 | 13 | 12 | 11 | 10 | 9 | 8 | 7 | 6 | 5 | 4 | 3 | 2 | 1 | 0 |
| Consist. | | Reserved | | Uniqueness factor | | | | | | | | P ₂ | | | | P ₁ | | | | | | | | | | | | | | | |

P₁ SGM penalty for small disparity variations (see Section 4.3). Default value: 6.

P₂ SGM penalty for large disparity variations (see Section 4.3). Default value: 22.

Uniqueness Factor Uniqueness factor q times 256. A value of 0 disables the uniqueness check (see Section 4.4.2). Default value: 320.

Consist. Consistency check threshold t_c (see Section 4.4.3). Default value: 2.

11.2.4 0x0C: Algorithm Parameters 2

Further algorithmic parameters that can be changed at run-time.

| | | | | | | | | | | | | | | | | | | | | | | | | | | | | | | | |
|----------|----|----|----|----|----|----|----|----|----|-------------------|----|----|----|----------|----|----|----|----|----|----|----|---|---|---|---|---|---|---|---|---|---|
| 31 | 30 | 29 | 28 | 27 | 26 | 25 | 24 | 23 | 22 | 21 | 20 | 19 | 18 | 17 | 16 | 15 | 14 | 13 | 12 | 11 | 10 | 9 | 8 | 7 | 6 | 5 | 4 | 3 | 2 | 1 | 0 |
| Reserved | | | | | | | | | | Texture threshold | | | | Reserved | | S | N | G | C | | | | | | | | | | | | |

C If set to 1 then the consistency check is disabled (see Section 4.4.3). Default value: 0.

G If set to 1 then the gap interpolation is disabled (see Section 4.5.3). Default value: 0.

N If set to 1 then the noise reduction is disabled (see Section 4.5.4). Default value: 0.

S If set to 1 then the speckle filtering is disabled (see Section 4.5.2). Default value: 0.

Texture threshold Threshold for the texture filter. A value of 0 disables the texture filter (see Section 4.5.1). Default value: 10.

11.2.5 0x10: License Key Higher 32 Bits

The most-significant 32 bits of the device-specific license key.

| | | | | | | | | | | | | | | | | | | | | | | | | | | | | | | | |
|---------------------------|----|----|----|----|----|----|----|----|----|----|----|----|----|----|----|----|----|----|----|----|----|---|---|---|---|---|---|---|---|---|---|
| 31 | 30 | 29 | 28 | 27 | 26 | 25 | 24 | 23 | 22 | 21 | 20 | 19 | 18 | 17 | 16 | 15 | 14 | 13 | 12 | 11 | 10 | 9 | 8 | 7 | 6 | 5 | 4 | 3 | 2 | 1 | 0 |
| License key bits 63 to 32 | | | | | | | | | | | | | | | | | | | | | | | | | | | | | | | |

11.2.6 0x14: License Key Lower 32 Bits

The least-significant 32 bits of the device-specific license key.

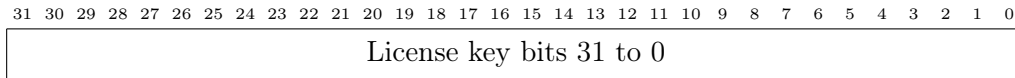

11.2.7 0x18: Device DNA Higher 25 Bits

The most significant 25 bits of the 57-bit Xilinx device DNA.

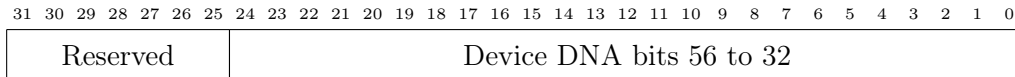

11.2.8 0x1C: Device DNA Lower 32 Bits

The least significant 32 bits of the 57-bit Xilinx device DNA.

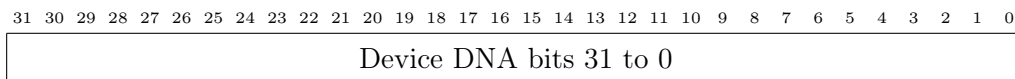

12 Reference Design

When using the SVC in combination with the DMA core, it is important to connect the DMA core's `clk` and the SVC's `base_clk` clock inputs to the same clock source. All input and output signals of both IP cores are associated with this clock. The SVC's `fast_clk` input can be connected to a faster clock, as described in Section 8 on page 17.

All inputs and outputs of the SVC shall be connected to the DMA core. The SVC's `resetn` input shall be connected to the DMA core's `system_resetn` output, such that it will also be reset when triggering a soft reset through DMA core's register 0x00.

When using the provided IP cores on a Zynq SoC, it is usually desired that processing can be controlled by software, which is run on the Zynq's CPU cores. This requires that the device registers of both IP cores can be read and written from software. To facilitate this, the `register_io` ports of the SVC and DMA core need to be connected to one of the Zynq's general purpose AXI master interfaces. This requires an instance of the AXI interconnect IP. Both ports need to be mapped to different address ranges through the IP Integrator address editor.

The DMA core's `*_dma` ports can be connected to the Zynq's high performance AXI slave interfaces. This allows reading input data from system memory, and writing the processing results back to memory. Please refer to Figure 10 for an illustration of the full reference design for a Zynq SoC.

13 Control Flow

When using the DMA core, it is necessary to write to several device registers for processing an input stereo frame. As writing to some of these registers triggers certain actions, it is important to access them in a defined order. While many different access

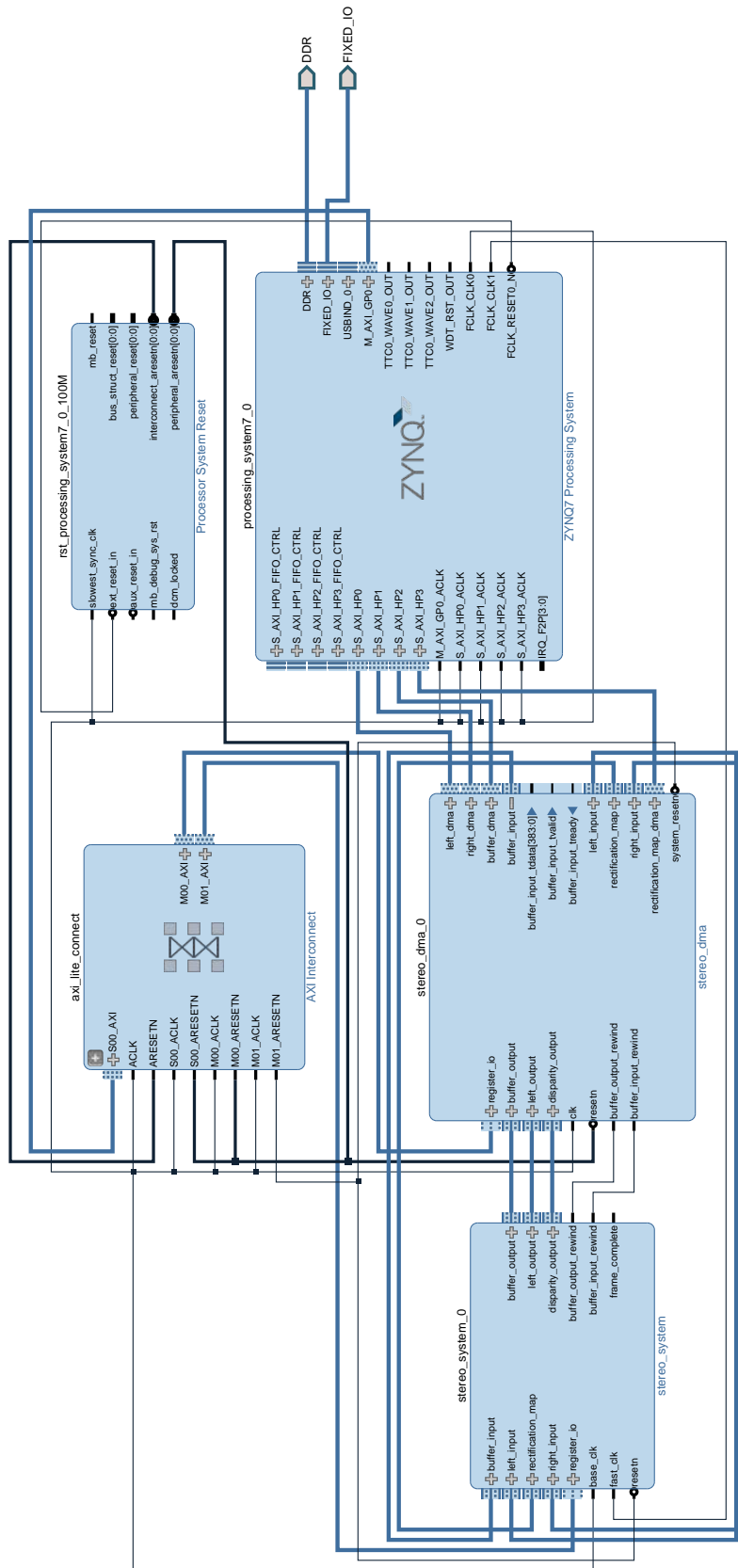

Figure 10: Reference design for Zynq SoC in IP Integrator.

patterns lead to the desired result, we recommend using the reference control flow detailed in this section.

13.1 One-Time Initializations

After a hard or a soft reset the following registers should be written:

1. A value of 0 to DMA register 0x1C (*left input bytes available*).
2. A value of 0 to DMA register 0x24 (*right input bytes available*).
3. Number of iterations to DMA register 0x00 (*control*).
4. Buffer memory address to DMA register 0x34 (*buffer address*).
5. Input image dimensions to DMA register 0x08 (*image size*).
6. License key most-significant 32 bits to SVC register 0x10.
7. License key least-significant 32 bits to SVC register 0x14.
8. Number of iterations and desired offset to SVC register 0x00 (*control*).
9. Input image dimensions to SVC register 0x04 (*image size*).
10. Algorithm parameters to SVC register 0x08 (*algorithm parameters 1*).
11. Algorithm parameters to SVC register 0x0C (*algorithm parameters 2*).
12. Operation mode to write SVC 0x00 (*control*).

13.2 Per-Frame Control Flow

For each frame that should be processed, the following registers have to be written:

1. A value of 0 to DMA register 0x1C (*left input bytes available*).
2. A value of 0 to DMA register 0x24 (*right input bytes available*).
3. Output address to DMA register 0x0C (*output address*).
4. Left input address to DMA register 0x18 (*left input address*).
5. Right input address to DMA register 0x20 (*right input address*).
6. Rectification map input address to DMA register 0x2C (*rectification map address*).
7. Available left input bytes to DMA register 0x1C (*left input bytes available*).
8. Available right input bytes to DMA register 0x24 (*right input bytes available*).

13.3 Result Retrieval

When using the DMA core, the processing results can be retrieved directly from the selected memory location that has been written to DMA register 0x0C (*output address*). The number of valid output bytes can be read from DMA register 0x10 (*output bytes available*). Processing is complete once this counter is equal to the expected output size (see Section 5.3). Alternatively, one can monitor the status bits in DMA register 0x04 (*status*) to determine when processing has finished.

Revision History

| Revision | Date | Author(s) | Description |
|----------|-------------------|-----------|--|
| v1.7 | February 23, 2017 | KS | Added description of concurrent of concurrent read / write bursts. |
| v1.6 | January 27, 2017 | KS | Fixes to control flow description. |
| v1.5 | January 24, 2017 | KS | Configurable disparity range and other updates for new IP core version 2.0. |
| v1.4 | July 19, 2016 | KS | Updated for new AXI interface. Added processing parameter recommendations. |
| v1.3 | July 4, 2016 | KS | Texture filter; updated timing and resource usage; changed AXI ID width. |
| v1.2 | March 16, 2016 | KS | Multi-clock design; speckle filter; variable image sizes; updated default parameterization, resource usage, timing and device registers. |
| v1.1 | July 15, 2015 | KS | Updated timing, resource usage and reference parameterization for optimized SVC. |
| v1.0 | June 20, 2015 | KS | Simplification of Section 2; minor rewording. |
| v0.2 | June 4, 2015 | KS | Split IP core into SVC and DMA core; added output merging; added subpixel optimization; updated resource usage, timing and registers to current version. |
| v0.1 | April 10, 2015 | KS | Initial revision |

References

- ARM (2010). AMBA 4 AXI4-Stream Protocol. ARM IHI 0051A (ID030510).
- ARM (2013). AMBA AXI and ACE Protocol Specification. ARM IHI 0022E (ID022613).
- Hirschmüller, H. (2005). Accurate and Efficient Stereo Processing by Semi-Global Matching and Mutual Information. In *IEEE Conference on Computer Vision and Pattern Recognition (CVPR)*, volume 2, pages 807–814.